

www.waya.co.in

India's Most Extensive Stock Holder & Distributors
of Prime Quality Steel Products



PRODUCT CATALOGUE

Introduction

Waya Industries was established in the year 2022 to be India's most extensive Stock Holders & Distributors of MS Seamless Pipes, GI Pipes, Hydraulic Tubes, Cylinder Tubes, MS Hollow Sections, MS ERW Pipes, Honed Tubes, Pre-Honed Tubes, Hard Chrome Plated Rods, Precision Tubes, Structural Steels catering to Hydraulic and Mechanical Industries of India.

The products supplied by us have a profound usage in the field of Heavy Engineering, Mechanical Industries, Machine Constructions, Industrial Sheds, Construction Equipments, Agricultures Machineries, Automobiles Industries, Dams, Earth Movers, Mobile Cranes, Material Handling Machine, Hydraulic Cylinders, Pneumatic Cylinders, Road Construction Machineries, Fuel Injection Applications, Gas & Petroleum Pipelines.

We offer Products in Various Grade, Sizes, Dimensions, Length, Thickness and Quality as per the requirement of the clients.

Industrial Steel Products

MS SEAMLESS PIPES

MS ERW PIPES

GI PIPES

MS HOLLOW SECTIONS

HYDRAULIC TUBES

CYLINDER TUBES

HONED TUBES

PRE-HONED TUBES

HARD CHROME PLATED RODS

PRECISION TUBES



We offer Products in Various Grade, Sizes, Dimensions,
Length, Thickness and Quality.

www.waya.co.in

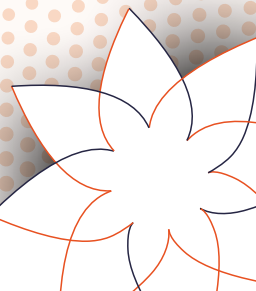

Industrial Steel Products



MS SEAMLESS PIPES

GRADES

ASTM A 106 Gr. B • ASTM A 335 • BS 3059
ASTM A 179 • DIN 2391 • EN 10305-1

PRODUCT SPECIFICATION

Outer Diameter : 4mm to 600mm
Thickness : 0.5mm to 50mm
Length Available upto : 8000m

MS ERW PIPES

GRADES

IS : 3589 MS ERW Pipes • IS : 4923
YST 355

PRODUCT SPECIFICATION

Size (NB) : 4mm to 600mm
Series : 0.5mm to 50mm
Outside Diameter : 21mm to 165mm

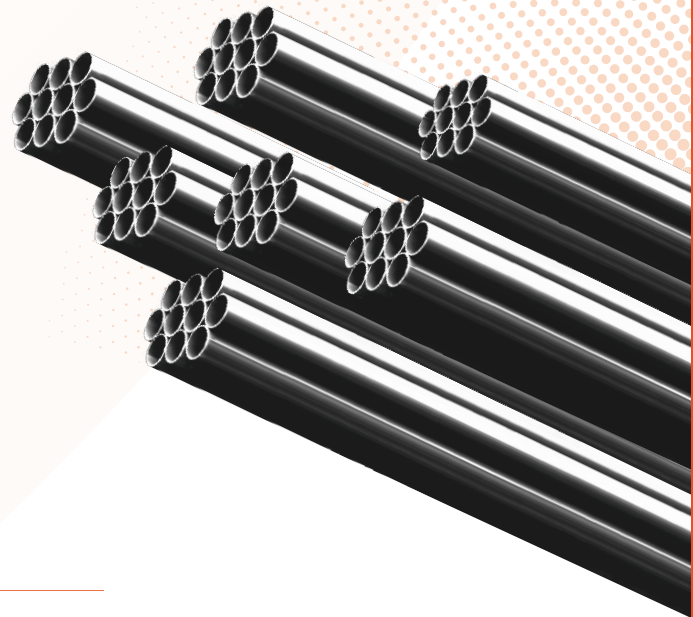
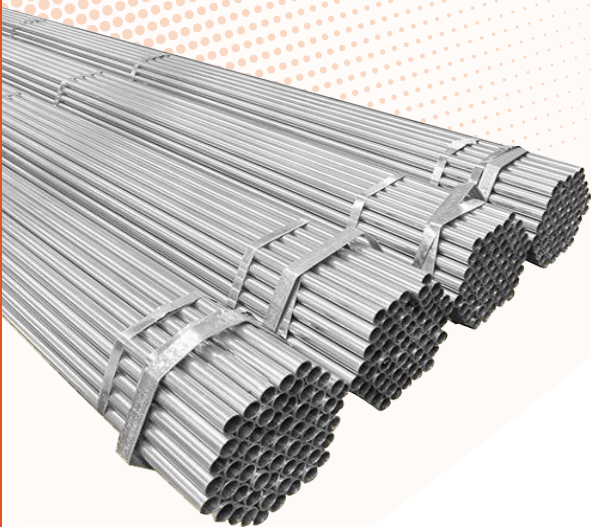

GI PIPES

GRADES

IS : 1239 Galvanised & Black Pipes

PRODUCT SPECIFICATION

Size (NB) : 4mm to 600mm
Series : 0.5mm to 50mm
Outside Diameter : 21mm to 165mm



Industrial Steel Products

MS HOLLOW SECTIONS

GRADES

ASTM A 500 • IS 4923 • YST 210
YST 240 • YST 310 • YST 355

PRODUCT SPECIFICATION

Sizes (SHS - BxB) : 25 X 25mm to 250 X 250mm
Thickness : 2mm to 10mm
Sizes (RHS - DxB) : 50 X 25mm to 300 X 200mm
Thickness : 2mm to 10mm

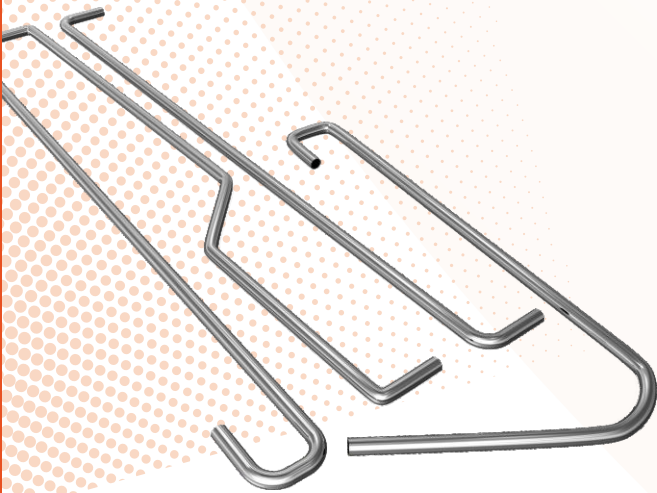
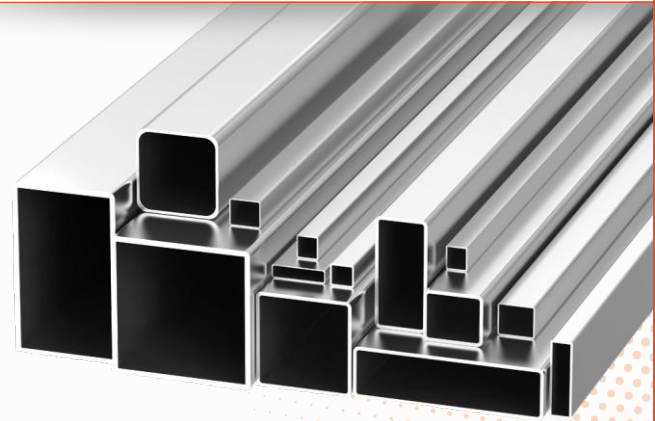

HYDRAULIC TUBES

GRADES

DIN 2391 ST 37 • ST 52 • EN 19 • ASTM A 106 Gr.B
EN 10305-1 • E 355

PRODUCT SPECIFICATION

Outer Diameter : As per Customer Requirement
Inner Diameter : Minimum 25 ID
Tolerance : H8

CYLINDER TUBES

GRADES

ST52 • EN19 • ASTM A 106 GR.B
EN 10305-1 • E355

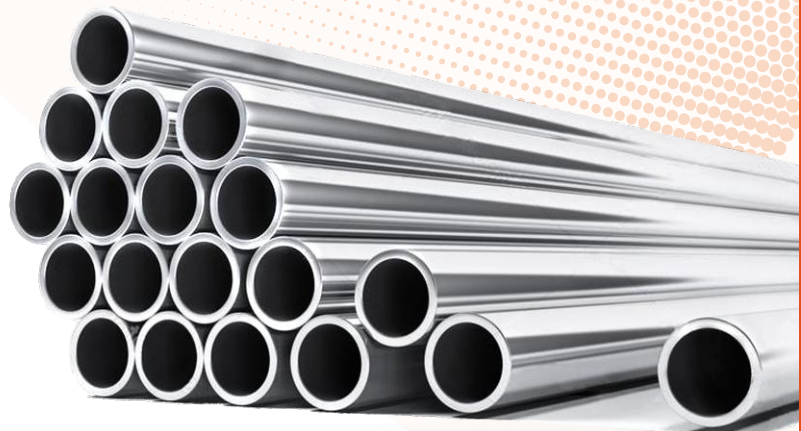

Industrial Steel Products

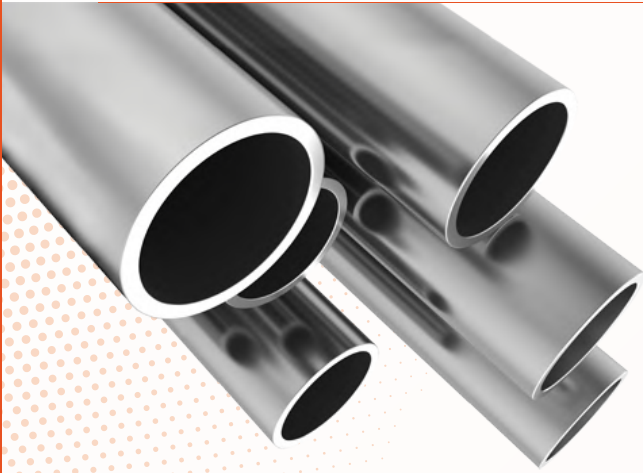

HONED TUBES

GRADES

ST52 Honed Tubes • EN 10305-1 Honed Tubes
DIN 2391 ST.52 (BK+S) Tolerance H8
EN 10305-1 E355+SR Tolerance H8
DIN 2391 ST.52 (BK+S) EN 10305-1 E355+SR
ASTM 106 Gr.B

PRODUCT SPECIFICATION

Outer Diameter : 32mm to 402mm
Thickness : 4mm to 26mm
Length Available upto : 8000m

HARD CHROME PLATED RODS

GRADES

CK-45 • C-45 • EN-8

PRODUCT SPECIFICATION

Outer Diameter : 10mm OD to 140mm OD
Chrome Thickness : 20 - 40 Microns
Surface Hardness : 850 - 1150 HV (Vickers 100g)
Tolerance on DIA : ISO f7 / f8 on the DIA
Length Available upto : 8000m

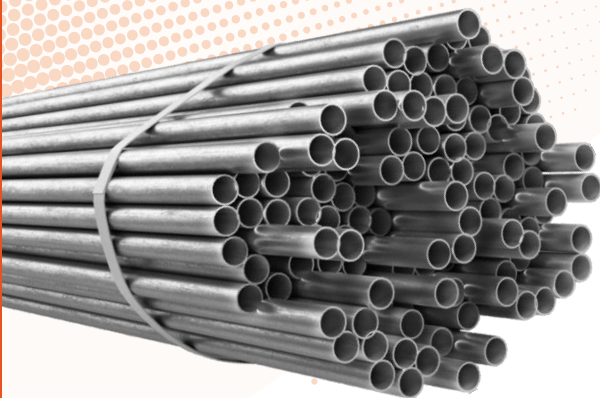
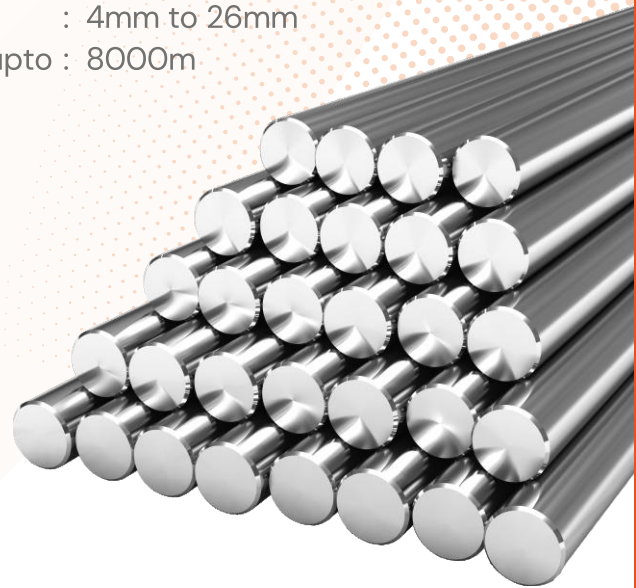

PRECISION TUBES

GRADES

DIN 2391 • DIN 2391 • DIN 17175 • EN 10305-1 • EN 10305-4

PRODUCT SPECIFICATION

Outer Diameter : 3mm to 40mm
Wall Thickness : 0.5mm to 7mm



Structural Steel Products

MS ROUND BARS

MS ANGLE

MS CHANNEL

MS I BEAM

MS H BEAM

MS FLAT

MS TEE SECTION

MS SQUARE BARS

MS HEX BARS

MS STEEL PLATES

HR-CR COILS & SHEETS

ROOFING PROFILE SHEETS

GI PIPES

GI SHEETS

MS TIE RODS

MS THREADED RODS

MS BINDING WIRES

TMT STEEL BARS

RUBBER CONVEYOR BELTS

We offer Products in Various Grade, Sizes, Dimensions,
Length, Thickness and Quality.

www.waya.co.in



Structural Steel Products

MS ROUND BARS

GRADES

EN-8 • EN-19 • CK - 45 • MS

PRODUCT SPECIFICATION

Size : 6mm - 25mm



MS ANGLE

GRADES

IS : 2062

PRODUCT SPECIFICATION

Size : 25mm x 25mm x 3-5mm to
200mm x 200mm x 16 - 20mm

MS CHANNEL

GRADES

IS : 2062

PRODUCT SPECIFICATION

Size : 75mm x 40mm to 200mm x 75mm

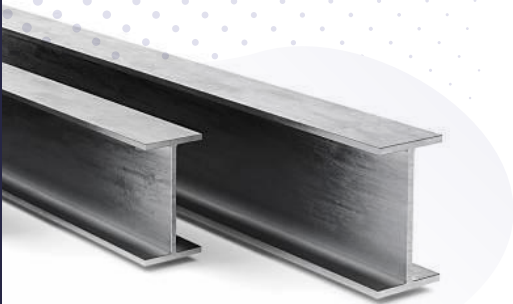
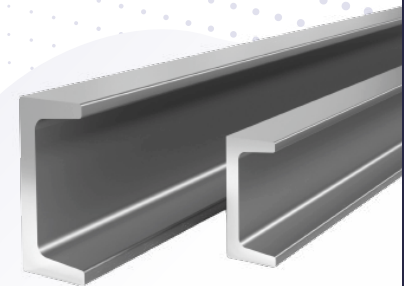

MS I BEAM

GRADES

IS : 2062

PRODUCT SPECIFICATION

Size : 100mm x 50mm to 600mm x 210mm

MS H BEAM

GRADES

IS : 2062

PRODUCT SPECIFICATION

Size : 100mm x 116mm to 300mm x 300mm

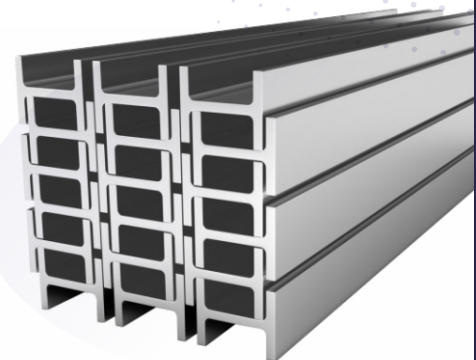

Structural Steel Products



MS FLAT

GRADES

IS : 2062 • Bright Flat • Black Flat

PRODUCT SPECIFICATION

Thickness : 6mm – 25mm
Width : 20mm – 100mm
Length : 5000mm – 6000mm

MS TEE SECTIONS

GRADES

MS

PRODUCT SPECIFICATION

Size : Provide as per Customer Requirements

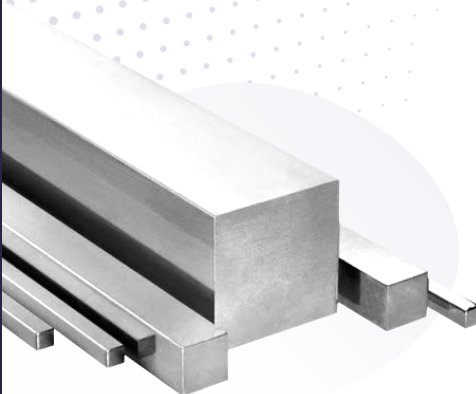
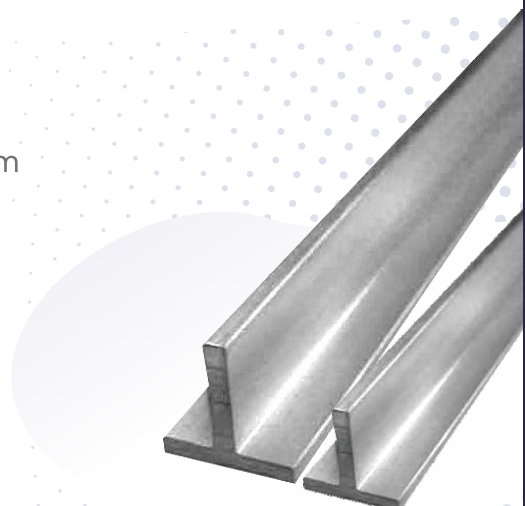

MS SQUARE BARS

GRADES

EN-8 • MS • Bright Square Bars

PRODUCT SPECIFICATION

Size : 20mm x 20mm – 100mm x 100mm

MS HEX BARS

GRADES

EN-36 • Bright Hex Bars • Stainless Steel

PRODUCT SPECIFICATION

Size : 10mm x 86mm

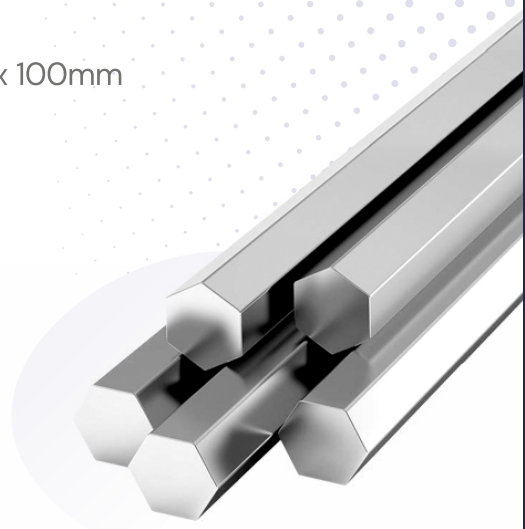

Structural Steel Products

MS STEEL PLATES

GRADES

IS : 2062 • E-250 / E-250 BR • E-350 / E-350 BR
SA 516 Grade 70 • Abrass 500 / 550 • Hardox 500
Salima Plates • ASTM A588

PRODUCT SPECIFICATION

Thickness : 2mm - 95mm
Width : 1500mm - 2500mm
Length : 6000mm - 6300mm

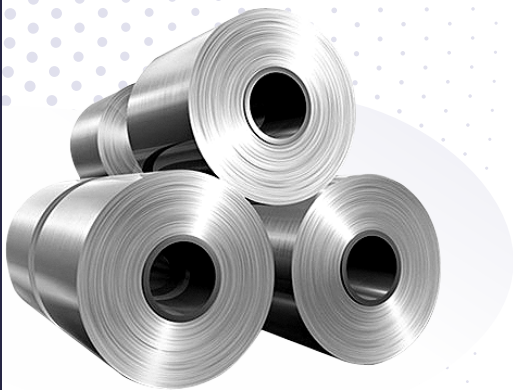
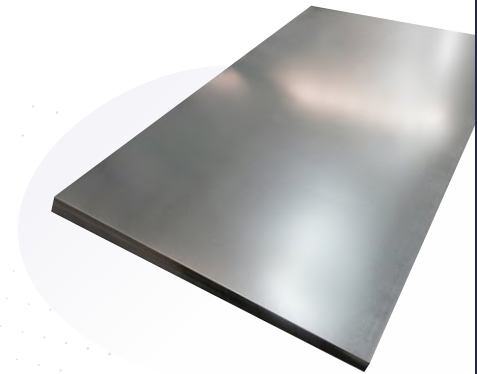

HR-CR COILS & SHEETS

GRADES

IS : 2062 • E-250 / E-250 BR • E-350 / E-350 BR
SA 516 Grade 70 • Abrass 500 / 550 • Hardox 500
Salima Plates • ASTM A588

PRODUCT SPECIFICATION

Thickness : 2mm - 95mm
Width : 1500mm - 2500mm
Length : 6000mm - 6300mm

ROOFING PROFILE SHEETS

GRADES

Provide as per Customer Requirement

PRODUCT SPECIFICATION

Thickness : 0.50mm - 0.80mm
Length : According to the Requirement
Shape : Rectangular
Color : Blue / Green / Red / Pink / Orange / White / Bronze / Multicolor

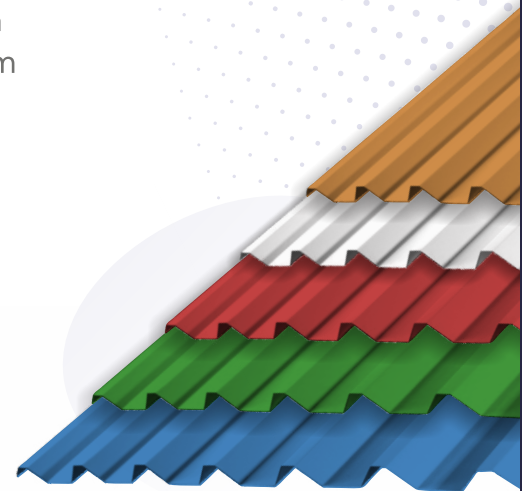

Structural Steel Products



GI PIPES

GRADES

IS : 1239 • Class A – Light • Class B – Medium • Class C – Heavy

PRODUCT SPECIFICATION

Thickness	: 2mm – 10mm
Min Nominal Size	: 1/8 NB
Max Nominal Size	: 24 NB
Min Outer Dimensions	: 19.05mm
Max Outer Dimensions	: 114.3mm
Length	: 6000mm – 12000mm

GI SHEETS

GRADES PRODUCT SPECIFICATION

IS : 1239 Size : 1220 X 2500mm – 1250 X 3100mm
Thickness : 0.8 mm – 2.5 mm

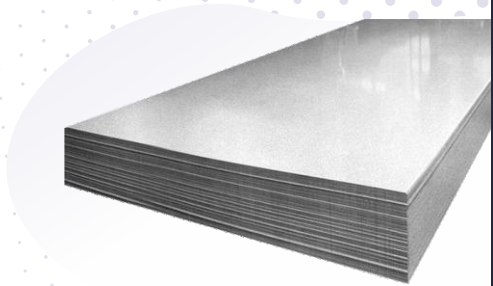

MS TIE RODS

GRADES PRODUCT SPECIFICATION

MS Thickness : 16mm

MS THREADED RODS

GRADES PRODUCT SPECIFICATION

MS Thickness : 16mm

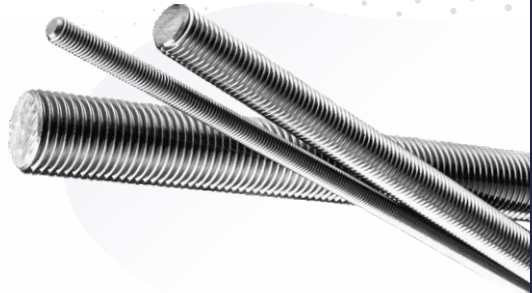

Structural Steel Products

TMT STEEL BARS

GRADES

Fe 415 • Fe 500 • Fe 500 D

PRODUCT SPECIFICATION

Size : 6mm to 40mm
(With Manufacturing Test Certificate)

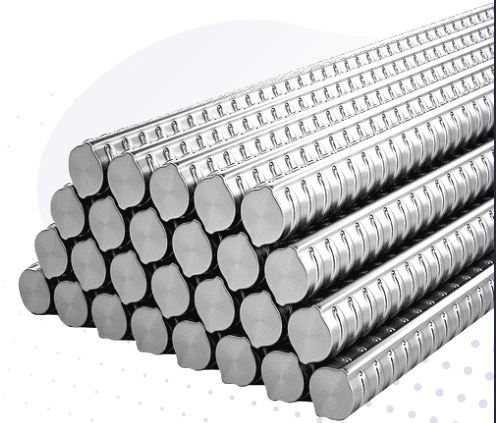

MS BINDING WIRES

GRADES

MS

PRODUCT SPECIFICATION

Size & Thickness :
Provide as per Customer Requirement

RUBBER CONVEYOR BELTS

GRADES

MS

PRODUCT SPECIFICATION

Width & Thickness :
Provide as per Customer Requirement

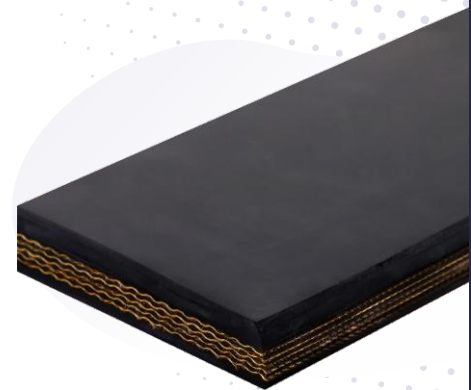

DOING BUSINESS WITH US HAS THE FOLLOWING BENEFITS FOR CUSTOMER

LARGE INVENTORY OF PRIME QUALITY MATERIAL

STANDARD SIZES AVAILABLE IN READY STOCK

NON-STANDARD SIZES CAN ALSO BE DELIVERED IN LEAD TIMES

LENGTH AVAILABLE UPTO 12 METERS LONG

SMALL QUANTITIES ARE ALSO DELIVERED

ECONOMICAL PRICING

QUALITY CONFIRMING TO INTERNATIONAL STANDARDS

MATERIAL TEST CERTIFICATION FOR QUALITY ASSURANCE

TECHNICAL QUALIFIED AFTER SALES

EXCELLENT DELIVERY CONDITIONS

DISTRIBUTION NETWORK ALL OVER INDIA

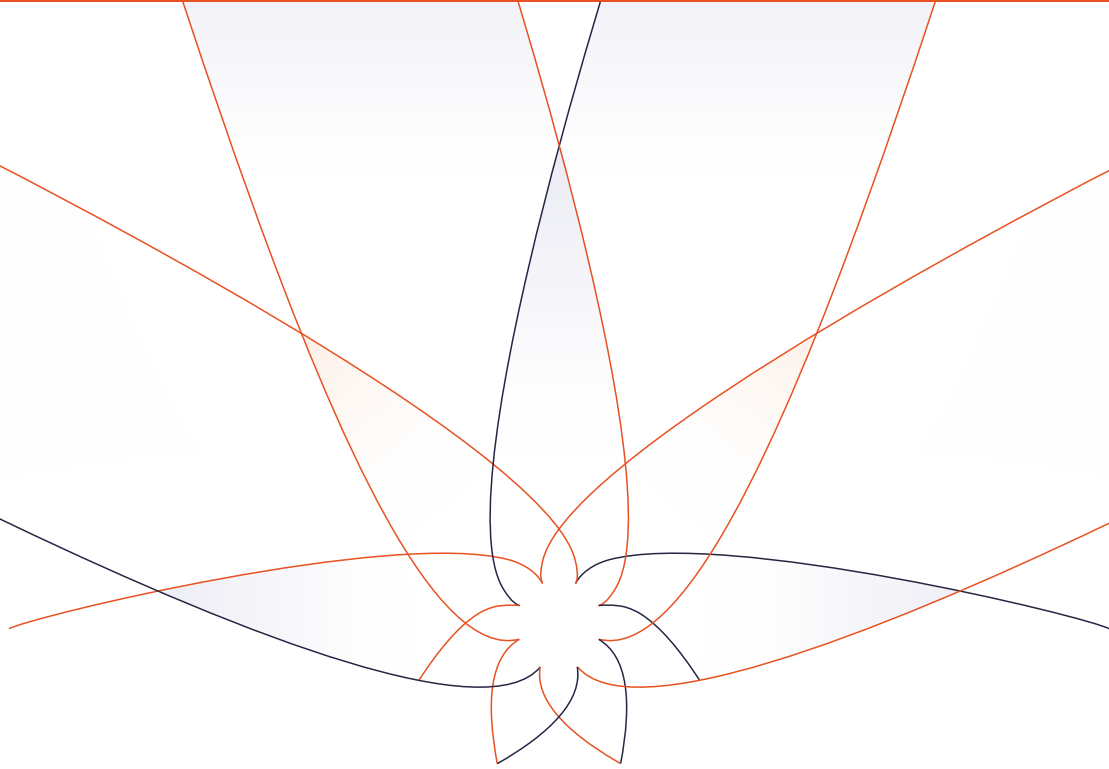

CONTACT US

Any Further Clarification Kindly Contact

Mr. Husain (Sales Manager)

M +91 7718900888 **E** sales@waya.co.in



C-513, 5th Floor, Steel Chambers Tower, Kalamboli,
Navi Mumbai – 410218. INDIA

T : +91 22 4601 4430

www.waya.co.in

